

# Systemske rešitve

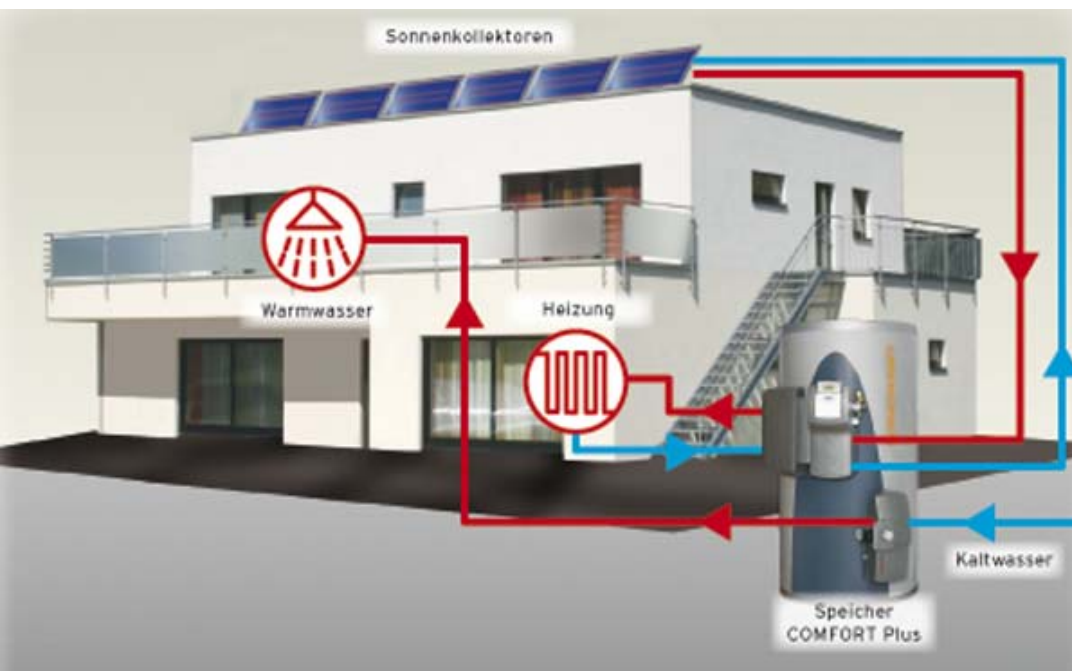

- COMPACT
- COMFORT
- COMFORT PLUS

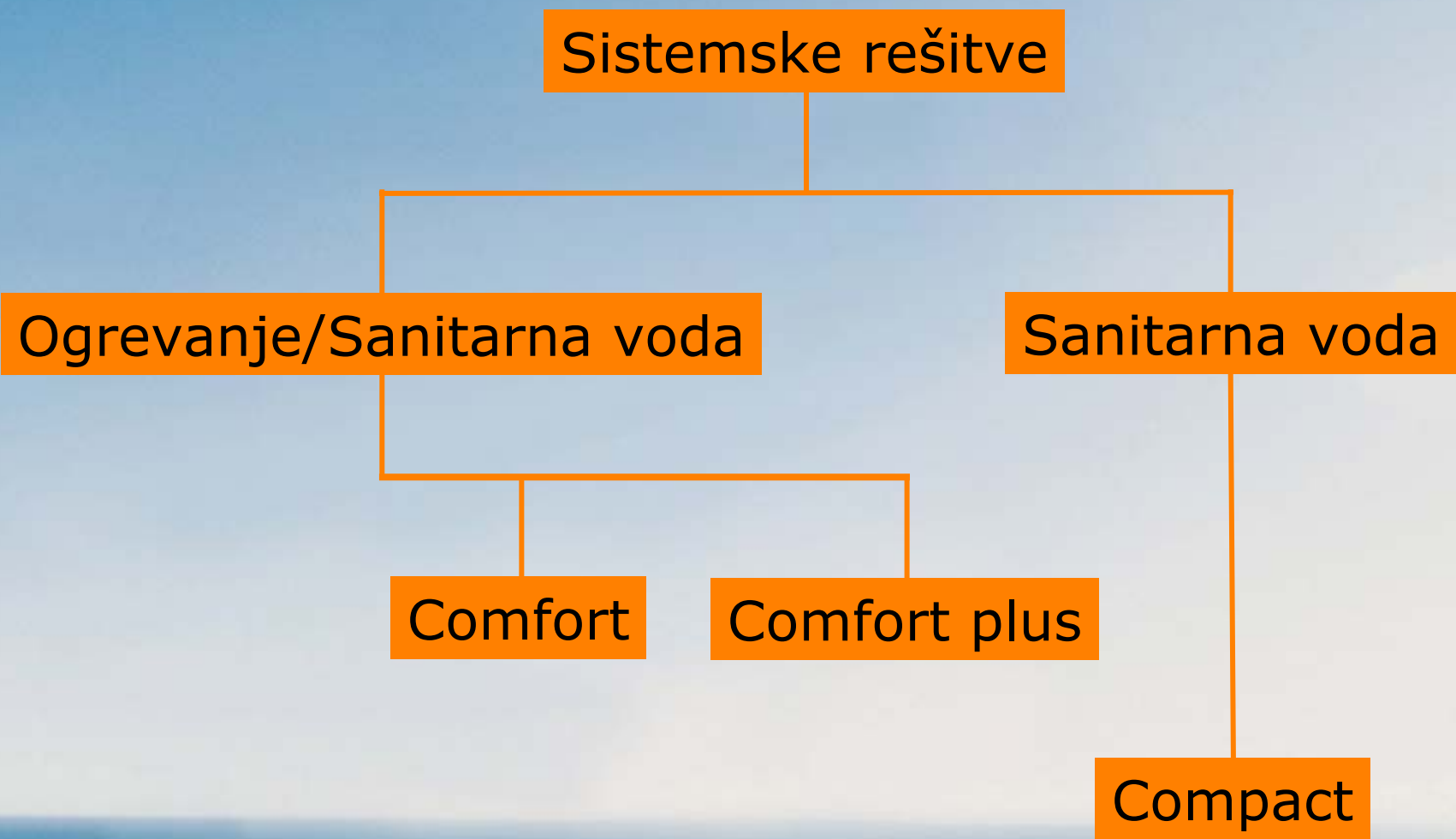



# **Sistemske rešitve COMPACT**





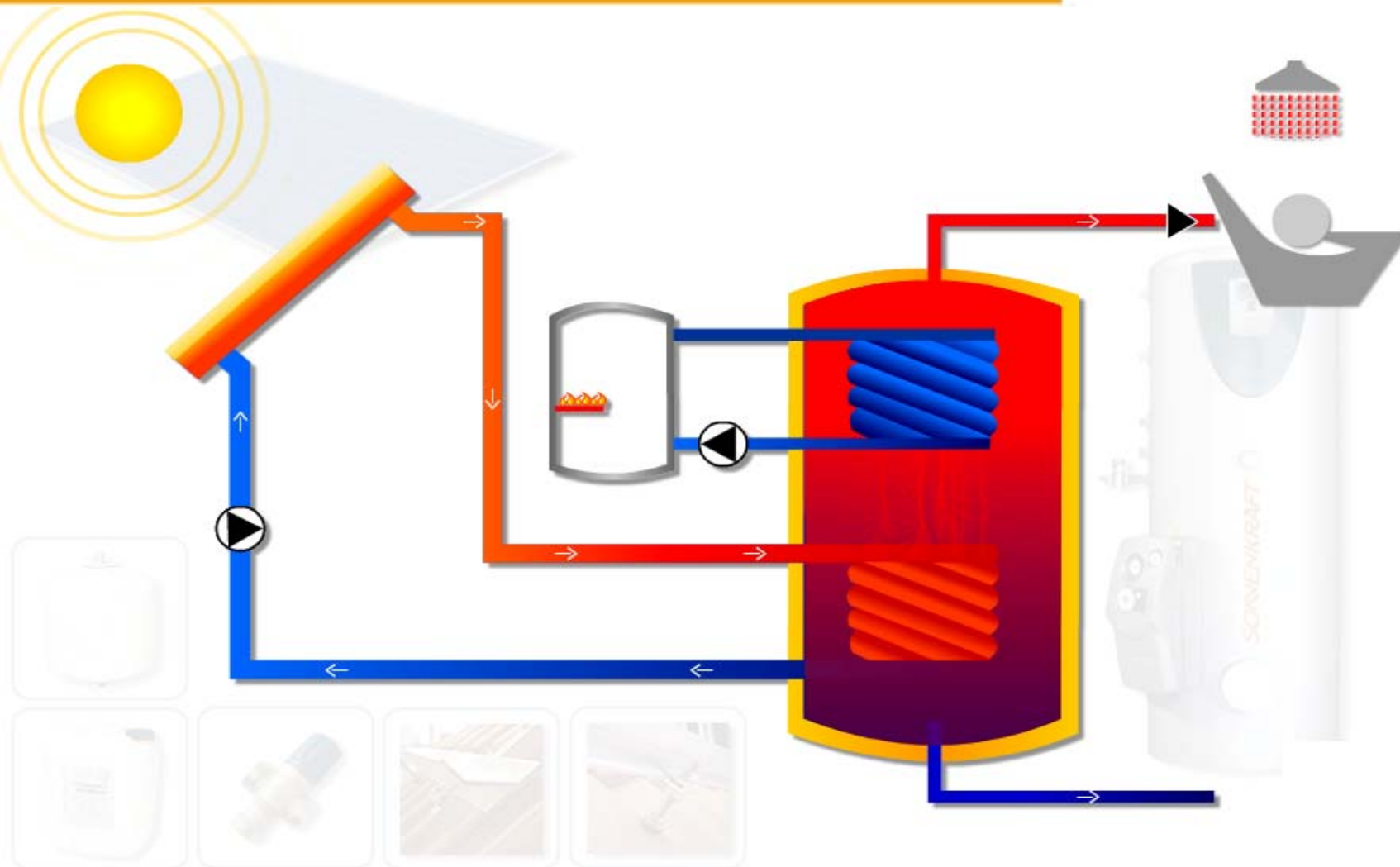

# COMPACT - dimenzioniranje

**Sonnenkraft.**

**Hitro in enostavno s pomočjo našega cenika:**

Warmwassersets			160 L	200 L	300 L	400 L
<b>Personen</b>	Pers.		1 - 3	1 - 3	2 - 4	3 - 5
Anzahl der Kollektoren (SK500/IDMK)	Stk.		1	1	2	3
Kollektorfläche	m <sup>2</sup>		2,5	2,5	5,1	7,5
<b>Sets MIT Befestigung/Blecheinfassung</b>			<b>2.150,-</b>	<b>2.390,-</b>	<b>3.290,-</b>	<b>4.290,-</b>
Aufdach SK500N	Befestigung Ziegeldach DBP	Art.Nr.	150 101	150 107	150 113	150 119
	Befestigung Universaldach SSP	Art.Nr.	150 102	150 108	150 114	150 120
Indach IDMK*	Blecheinfassung Ziegeldach DBP KZ	Art.Nr.	-	-	150 115	150 121
<b>Sets OHNE Befestigung/Blecheinfassung</b>			<b>1.990,-</b>	<b>2.290,-</b>	<b>3.150,-</b>	<b>4.120,-</b>
Aufdach SK500N	ohne Befestigung	Art.Nr.	150 104	150 110	150 116	150 122
Indach IDMK*	ohne Blecheinfassung	Art.Nr.	150 106	150 112	150 118	150 124
Aufdach SK500L	ohne Befestigung	Art.Nr.	150 105	150 111	150 117	150 123
<b>OPTION Wellrohrverbindungsset EWSID</b>			<b>590,-</b>	<b>590,-</b>	<b>590,-</b>	<b>590,-</b>
Wellrohrverbindung	IDMK	Art.Nr.	141 523	141 523	141 523	141 523
EWS-SET16 bzw. EWS-SET20, 15 lfm	SK500	Art.Nr.	141 524	141 524	141 524	141 524



















**Sistemske rešitve**

THE FUTURE OF ENERGY

# COMPACT - dimenzioniranje

**SOLARKRAFT**

**Hitro in enostavno s pomočjo našega cenika :**

Anzahl/Fläche der Kollektoren	Kollektor	Preis	Universaldach Stockschraubenbefestigungssysteme			Ziegeldach Dachbügelbefestigungssysteme	
			parallel SSP	20 ° angehoben SSA20	45 ° angehoben SSA45	parallel DBP	20 ° angehoben DBA20
Hinweis: Bitte wählen Sie das zur Dachart passende Befestigungssystem. Artikelnummern und Preise entnehmen Sie dieser Tabelle. Weitere Befestigungsmöglichkeiten auf Anfrage!			Kollektorfeld ohne Befestigung				
1 Stk./2,57 m <sup>2</sup>	 <b>SK500N</b>	<b>790,-</b>	 111 501 <b>134,-</b>	 111 531 <b>223,-</b>	 111 549 <b>262,-</b>	 111 601 <b>202,-</b>	 111 631 <b>276,-</b>
2 Stk./5,14 m <sup>2</sup>	 <b>SK500N</b>	<b>1.580,-</b>	111 502 <b>175,-</b>	111 532 <b>260,-</b>	111 550 <b>302,-</b>	111 602 <b>244,-</b>	111 632 <b>318,-</b>
3 Stk./7,71 m <sup>2</sup>	 <b>SK500N</b>	<b>2.370,-</b>	111 503 <b>267,-</b>	111 533 <b>401,-</b>	111 551 <b>459,-</b>	111 603 <b>372,-</b>	111 633 <b>480,-</b>
4 Stk./10,28 m <sup>2</sup>	 <b>SK500N</b>	<b>3.160,-</b>	111 504 <b>385,-</b>	111 534 <b>603,-</b>	111 552 <b>701,-</b>	111 604 <b>556,-</b>	111 634 <b>738,-</b>
5 Stk./12,85 m <sup>2</sup>	 <b>SK500N</b>	<b>3.950,-</b>	111 505 <b>475,-</b>	111 535 <b>743,-</b>	111 553 <b>856,-</b>	111 605 <b>685,-</b>	111 635 <b>899,-</b>
6 Stk./15,42 m <sup>2</sup>	 <b>SK500N</b>	<b>4.740,-</b>	111 506 <b>570,-</b>	111 536 <b>882,-</b>	111 554 <b>1.010,-</b>	111 606 <b>810,-</b>	111 636 <b>1.065,-</b>
1 Stk./2,57 m <sup>2</sup>	 <b>SK500L</b>	<b>810,-</b>	111 507 <b>168,-</b>	111 537 <b>223,-</b>	111 555 <b>237,-</b>	111 607 <b>223,-</b>	111 637 <b>267,-</b>
2 Stk./5,14 m <sup>2</sup>	 <b>SK500L</b>	<b>1.620,-</b>	111 508 <b>270,-</b>	111 538 <b>346,-</b>	111 556 <b>365,-</b>	111 608 <b>346,-</b>	111 638 <b>405,-</b>
3 Stk./7,71 m <sup>2</sup>	 <b>SK500L</b>	<b>2.430,-</b>	111 509 <b>420,-</b>	111 539 <b>554,-</b>	111 557 <b>584,-</b>	111 609 <b>554,-</b>	111 639 <b>654,-</b>
4 Stk./10,28 m <sup>2</sup>	 <b>SK500L</b>	<b>3.240,-</b>	111 510 <b>535,-</b>	111 540 <b>690,-</b>	111 558 <b>732,-</b>	111 610 <b>695,-</b>	111 640 <b>815,-</b>
5 Stk./12,85 m <sup>2</sup>	 <b>SK500L</b>	<b>4.050,-</b>	111 511 <b>695,-</b>	111 541 <b>897,-</b>	111 559 <b>955,-</b>	111 611 <b>897,-</b>	111 641 <b>1.055,-</b>
6 Stk./15,42 m <sup>2</sup>	 <b>SK500L</b>	<b>4.860,-</b>	111 512 <b>810,-</b>	111 542 <b>1.035,-</b>	111 560 <b>1.095,-</b>	111 612 <b>1.035,-</b>	111 642 <b>1.220,-</b>



**Sistemske rešitve**

THE FUTURE OF ENERGY



# COMPACT – shema sistema

**SOLNENKRAFT.**

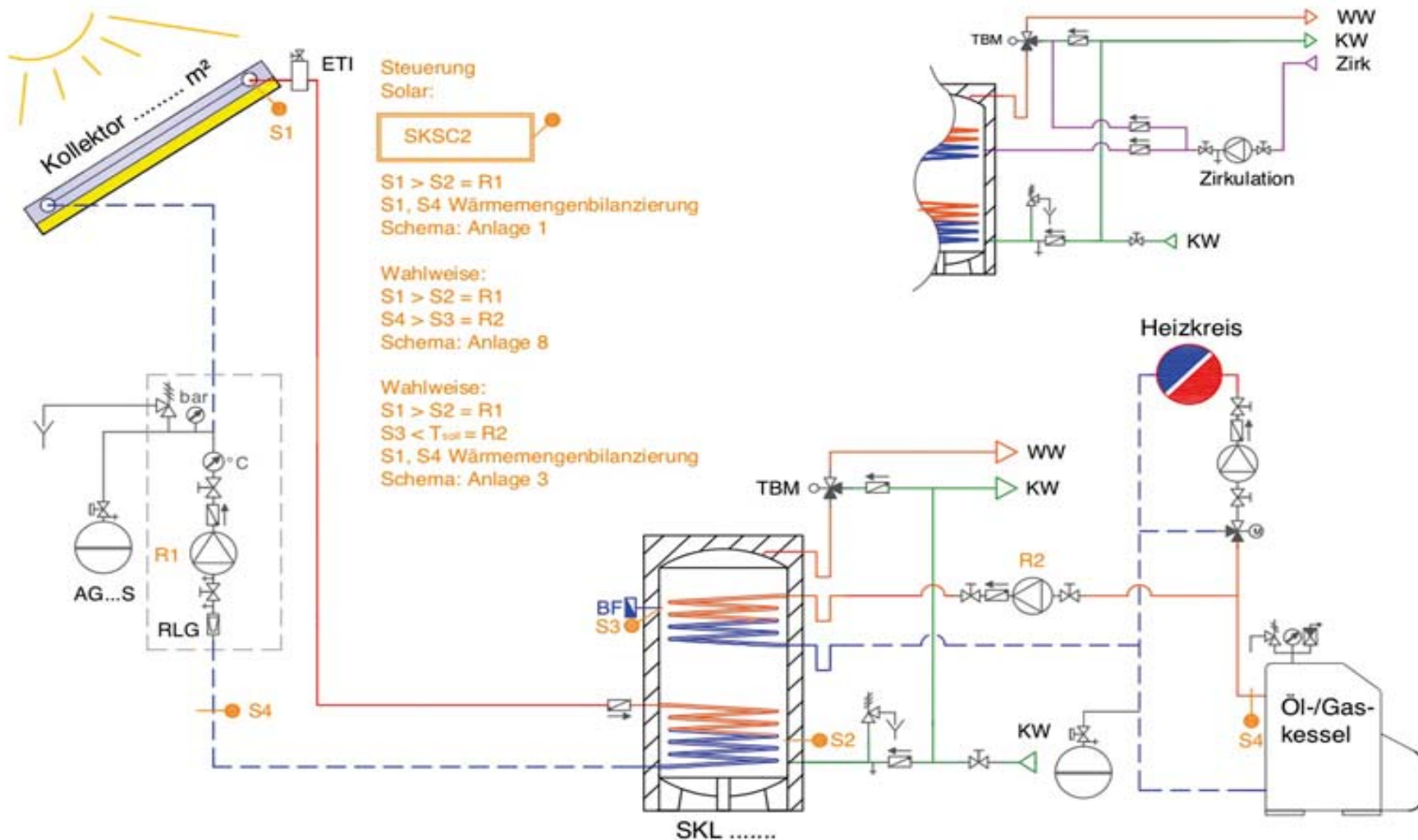

**Sistemske rešitve**

THE FUTURE OF ENERGY



# COMPACT – shema sistema

**Sonnenkraft.**

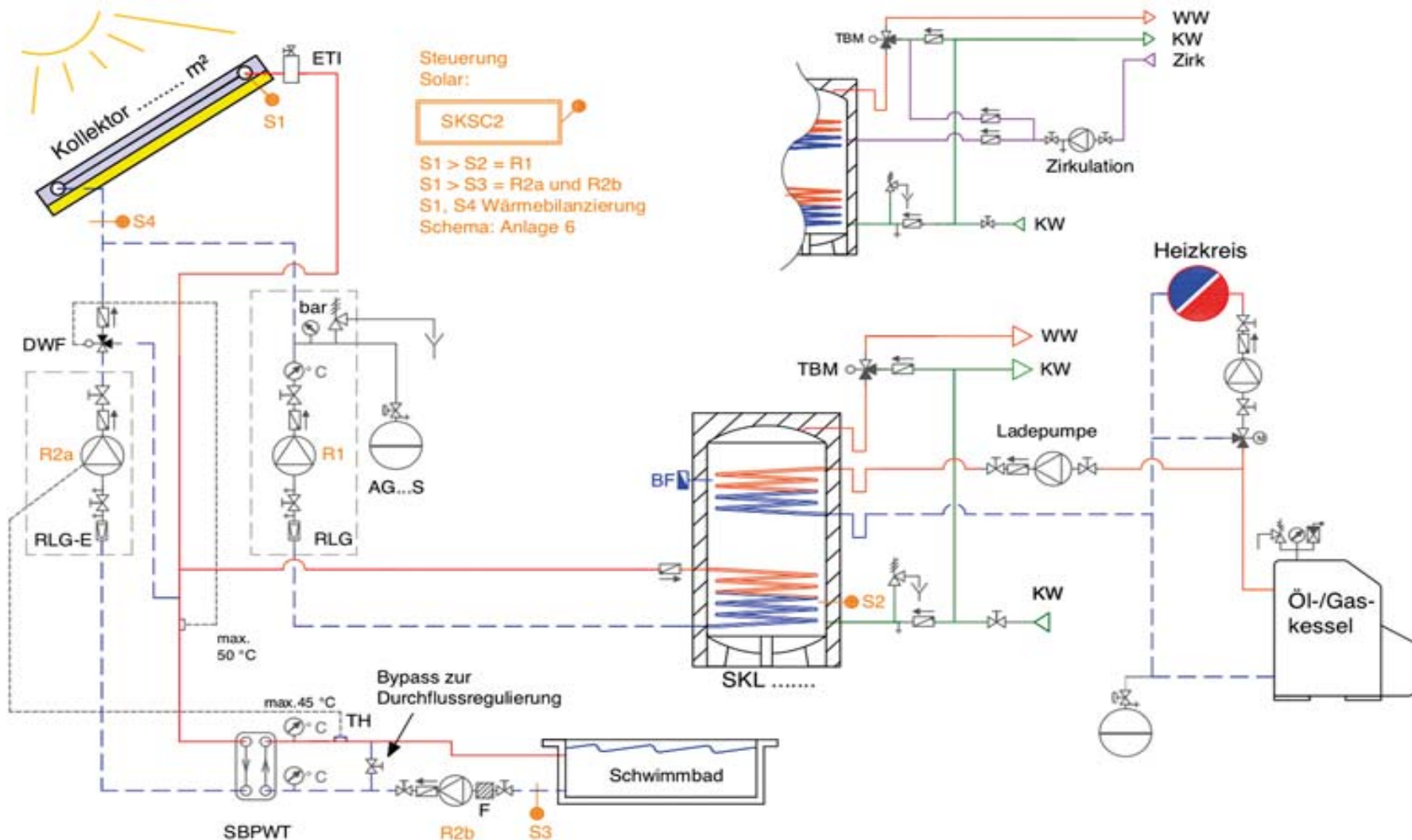

**Sistemske rešitve**

THE FUTURE OF ENERGY

COMPACT – primer v praksi

**Sonnenkraft**



**Sistemske rešitve**

Inhaltsverzeichnis

THE FUTURE OF ENERGY

# **Systemska rešitev COMFORT**



# **Systemska rešitev COMFORT (PSR)**





# COMFORT – prednosti

**SONENKRAFT.**



- solarno pokritost sistemih z nizkimi stroški  
doseženim prenosom  
- Podpora o  
- Priprava t
- sveža in higijena  
vode preko **pr**  
toplo sanitarn
- krajši časi r
- kompaktno



**Sistemske rešitve**



THE FUTURE OF ENERGY



# COMFORT - dimenzioniranje

**Sonnenkraft**

**Zelo enostavno s pomočjo naših cenikov:**

Solarsets			COMFORT Warmwassersets		COMFORT Heizungssets		
			500 L	500 L	500 L	800 L	1000 L
<b>Personen</b>	Pers.		5 - 6	6 - 8	2 - 4	2 - 5	4 - 6
Anzahl der Kollektoren (SK500/IDMK)	Stk.		3x 	4x 	4x 	5x 	6x 
Kollektorfläche	m <sup>2</sup>		7,5	10,1	10,1	12,5	15,1
<b>Sets MIT Befestigung/Blecheinfassung</b>			<b>5.890,-</b>	<b>6.550,-</b>	<b>6.550,-</b>	<b>7.550,-</b>	<b>8.550,-</b>
Aufdach SK500N 	Befestigung Ziegeldach DBP 	Art.Nr.	150 447	150 401	150 401	150 407	150 413
	Befestigung Universaldach SSP 	Art.Nr.	150 448	150 402	150 402	150 408	150 414
Indach IDMK* 	Blecheinfassung Ziegeldach BEFKZ 	Art.Nr.	150 449	150 403	150 403	150 409	150 415
<b>Sets OHNE Befestigung/Blecheinfassung</b>			<b>5.550,-</b>	<b>6.150,-</b>	<b>6.150,-</b>	<b>7.090,-</b>	<b>7.990,-</b>
Aufdach SK500N 	ohne Befestigung	Art.Nr.	150 450	150 404	150 404	150 410	150 416
Indach IDMK* 	ohne Blecheinfassung	Art.Nr.	150 452	150 406	150 406	150 412	150 418
Aufdach SK500L 	ohne Befestigung	Art.Nr.	150 451	150 405	150 405	150 411	150 417
<b>OPTION Wellrohrverbindungsset EWSID</b>			<b>590,-</b>	<b>740,-</b>	<b>740,-</b>	<b>740,-</b>	<b>740,-</b>
Wellrohrverbindung	IDMK	Art.Nr.	141 523	141 525	141 525	141 525	141 525
<b>EWS-SET16</b> bzw. <b>EWS-SET20</b> , 15 lfm	SK500	Art.Nr.	141 524	141 526	141 526	141 526	141 526
<b>Set-Komponenten</b>							
COMFORT-Speicher	Type		PSR500	PSR500	PSR500	PSR800	PSR1000
Rücklaufgruppe PSKR inkl. 2-Kreis-Steuerung			✓	✓	✓	✓	✓
Frischwassermodul FWM35 inkl. FWMPVS			✓	✓	✓	✓	✓
Ausdehnungsgefäß	Type		AG25S	AG33S	AG33S	AG33S	AG50S
Frostschutz	I		15	20	20	20	25



**Sistemske rešitve**

THE FUTURE OF ENERGY



# Sodobna rešitev: FWM35

**Sonnenkraft**

- Pretočna zasnova zagotavlja 100 % čisto toplo pitno vodo, odpravlja nevarnost legionel
- Zahvaljujoč visoko zmogljivemu TI odjemna količina praktično enaka kot pri akumulacijskem grelniku
- Blokovna zasnova ⇒ kompaktna izvedba in minimalen potreben prostor
- Najpreprostejša montaža na steno in hranilnik PSR/PSC
- Optimalna možnost razširitve s sodobno cirkulacijsko črpalko FWMZP
- Pripravljeno za priključitev zahvaljujoč popolnemu električnemu predožičenju
- Višji izplen solarne naprave zahvaljujoč opustitvi dodatnega hranilnika

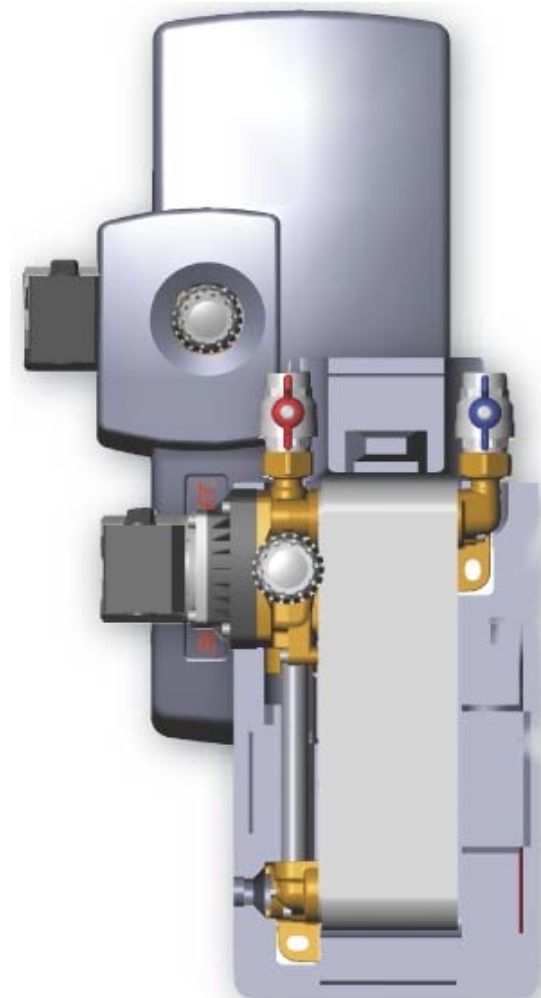

**Sistemske rešitve**

THE FUTURE OF ENERGY

# Shema delovanja FWM35

**Sonnenkraft**

VL iz hranilnika

Za doseganje željene temperature, dodajamo vodo iz hladnega povratnega voda

RL v hranilnik

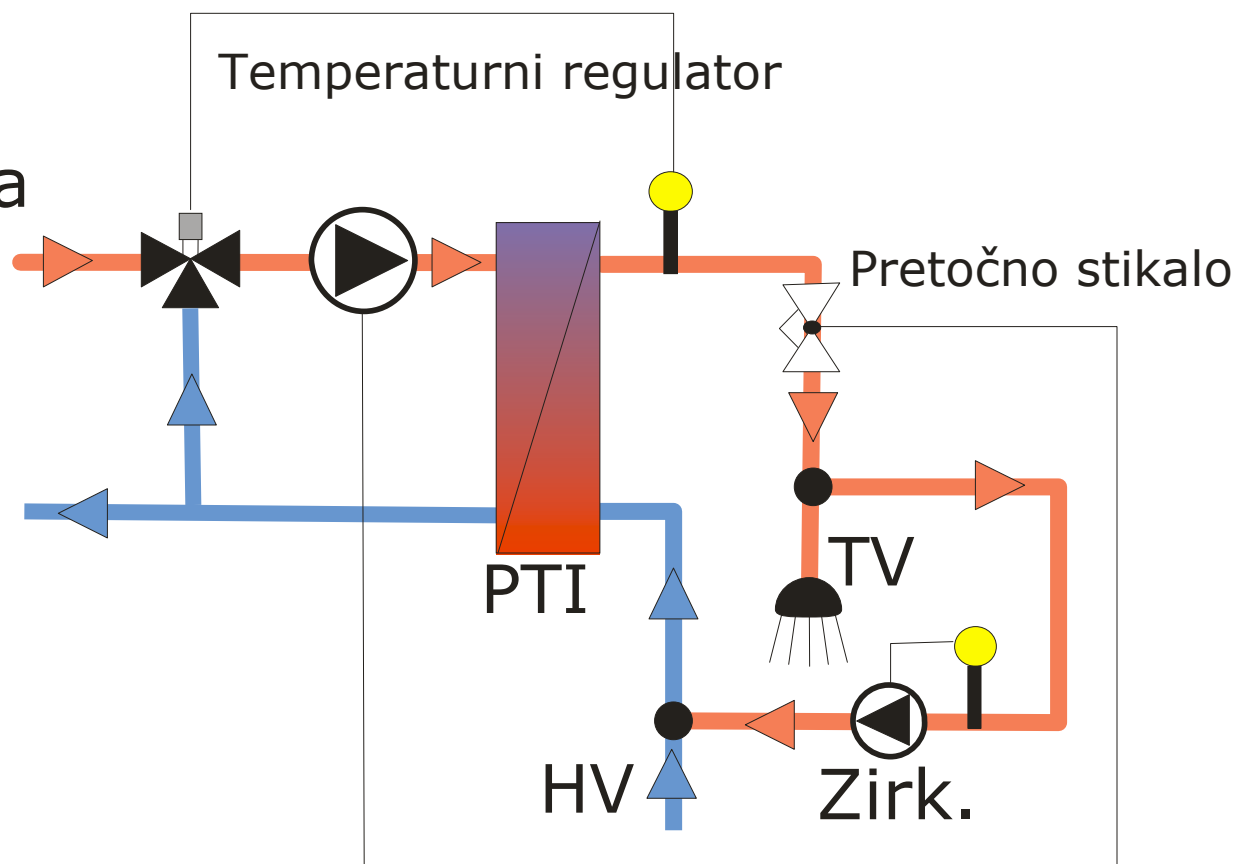

**Sistemske rešitve**

THE FUTURE OF ENERGY

# Cirkulacijska enota FWMZP

**Sonnenkraft**

- Najmanjša možna blokovna zasnova, brez dodatnih internih cevni napeljav
- Časovno ali po potrebah krmiljeno vklapljanje in termostatsko izklapljanje
- Toplotno izolirana izvedba
- V celoti pripravljena za hidravlični in električni priklop
- Preprost vtični priklop cirkulacijske enote na FWM35

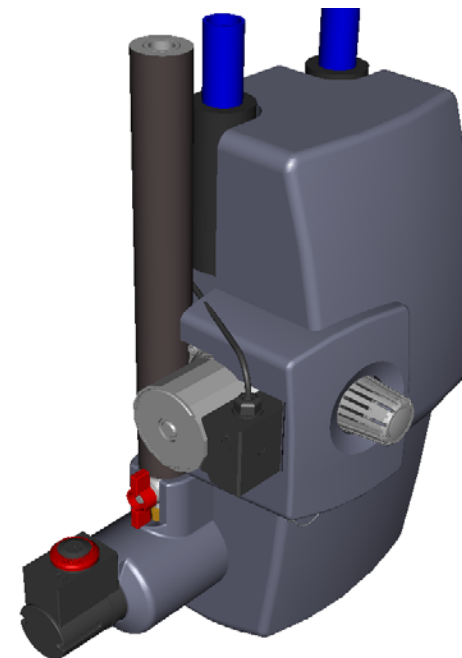
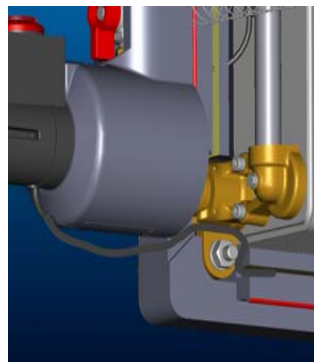
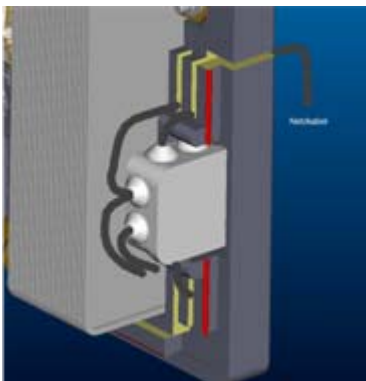

**Napotek:**

**Maks. dobavna višina = 1 m  
H<sub>2</sub>O pri minimalnem pretoku  
1,3 l/min**



**Sistemske rešitve**

THE FUTURE OF ENERGY

# COMFORT – shema sistema

**SOLNENKRAFT.**

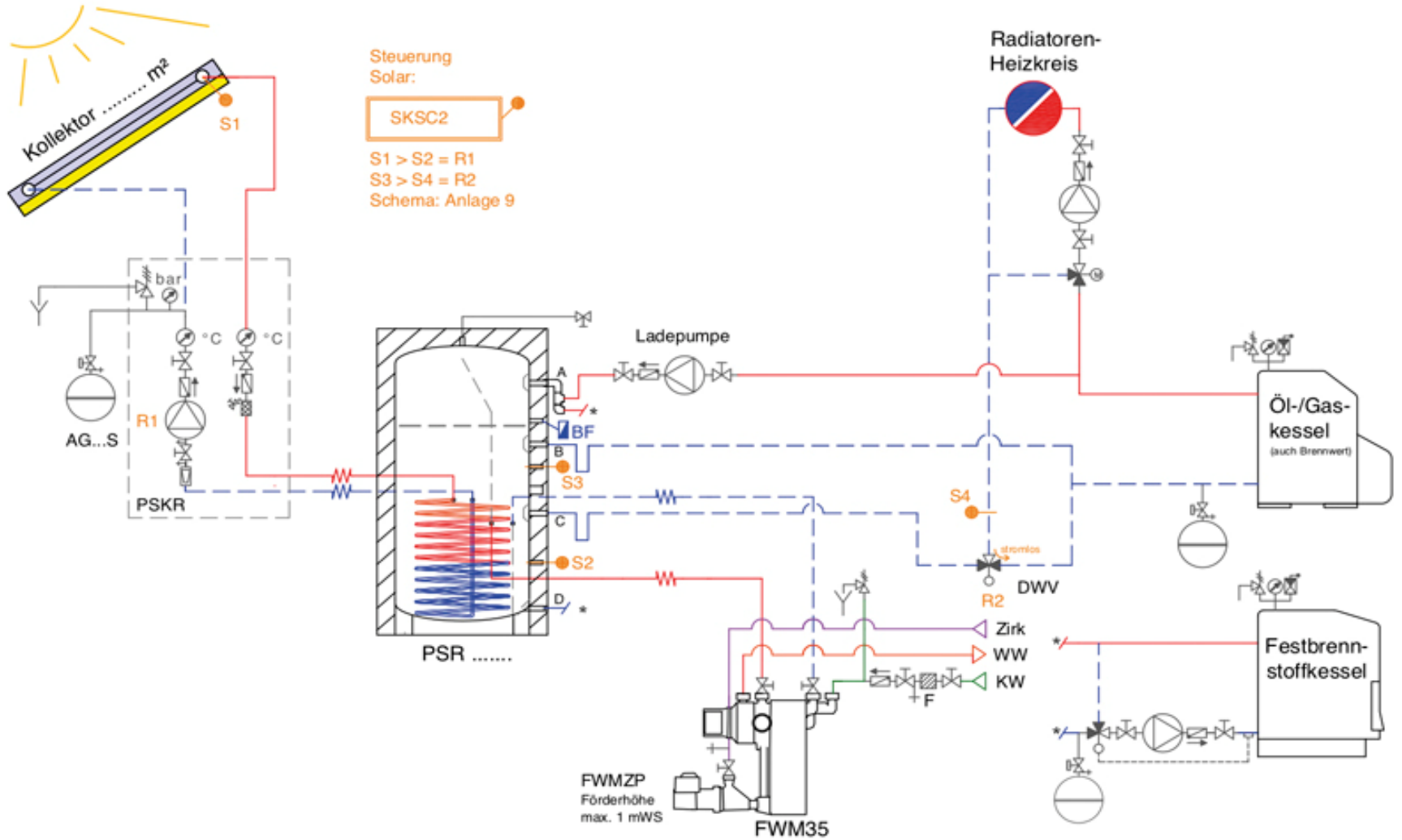

**Sistemske rešitve**

THE FUTURE OF ENERGY

# COMFORT – shema sistema

**Sonnenkraft.**

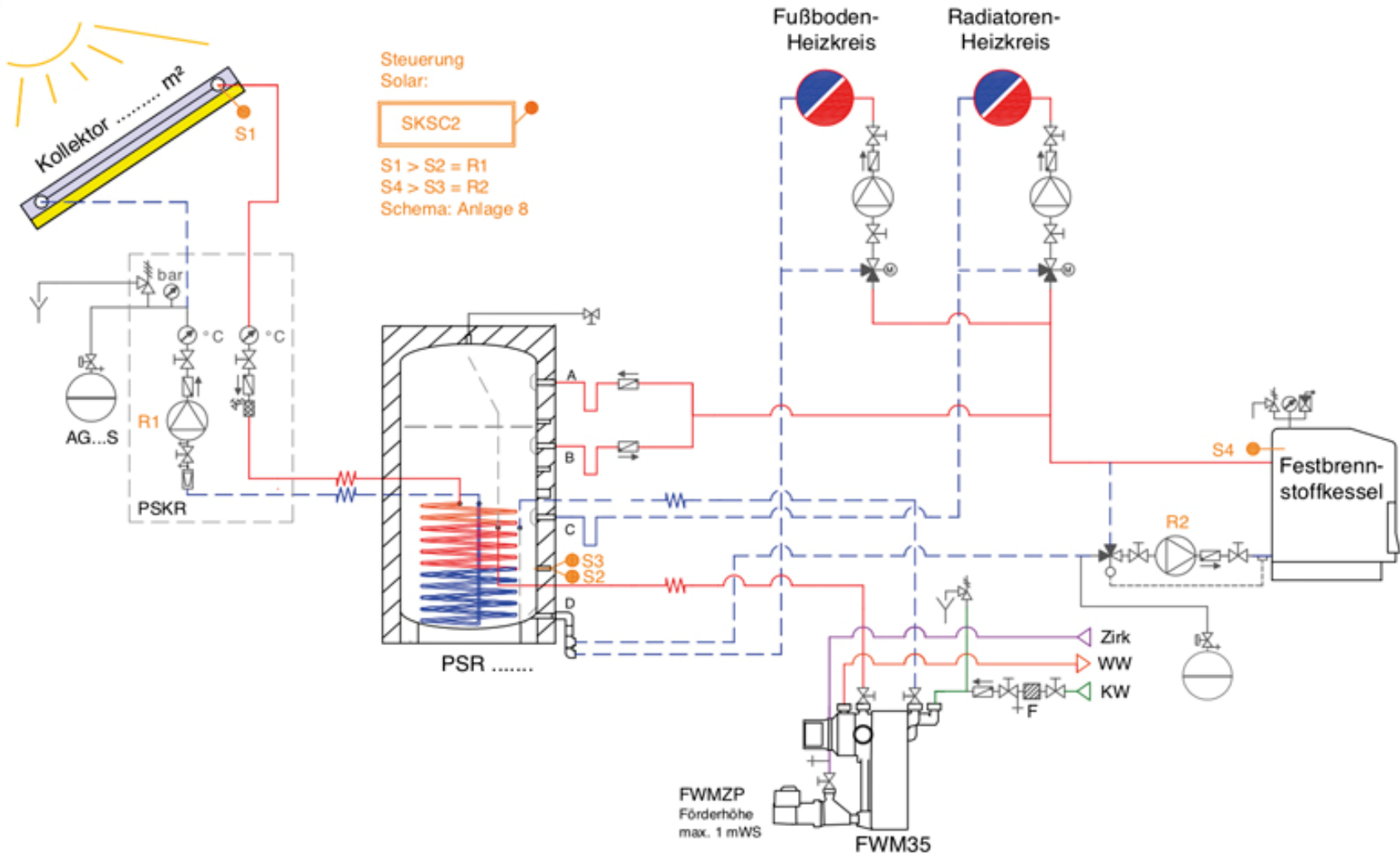

**Sistemske rešitve**

THE FUTURE OF ENERGY





**Sistemske rešitve**

THE FUTURE OF ENERGY

# **Systemska rešitev COMFORT plus (PSC)**





# COMFORT plus - prednosti

**Sonnenkraft.**

- solarno pokrivanje sistemih z nizko doseženim prihrankom energije
  - Podpora otopli
  - Priprava tople
- sveža in higijena voda preko p
- toplo sanitarno
- FWM35 do m
- krajši časi r
- optimalen iz
- plastno polnje



**Sistemske rešitve**



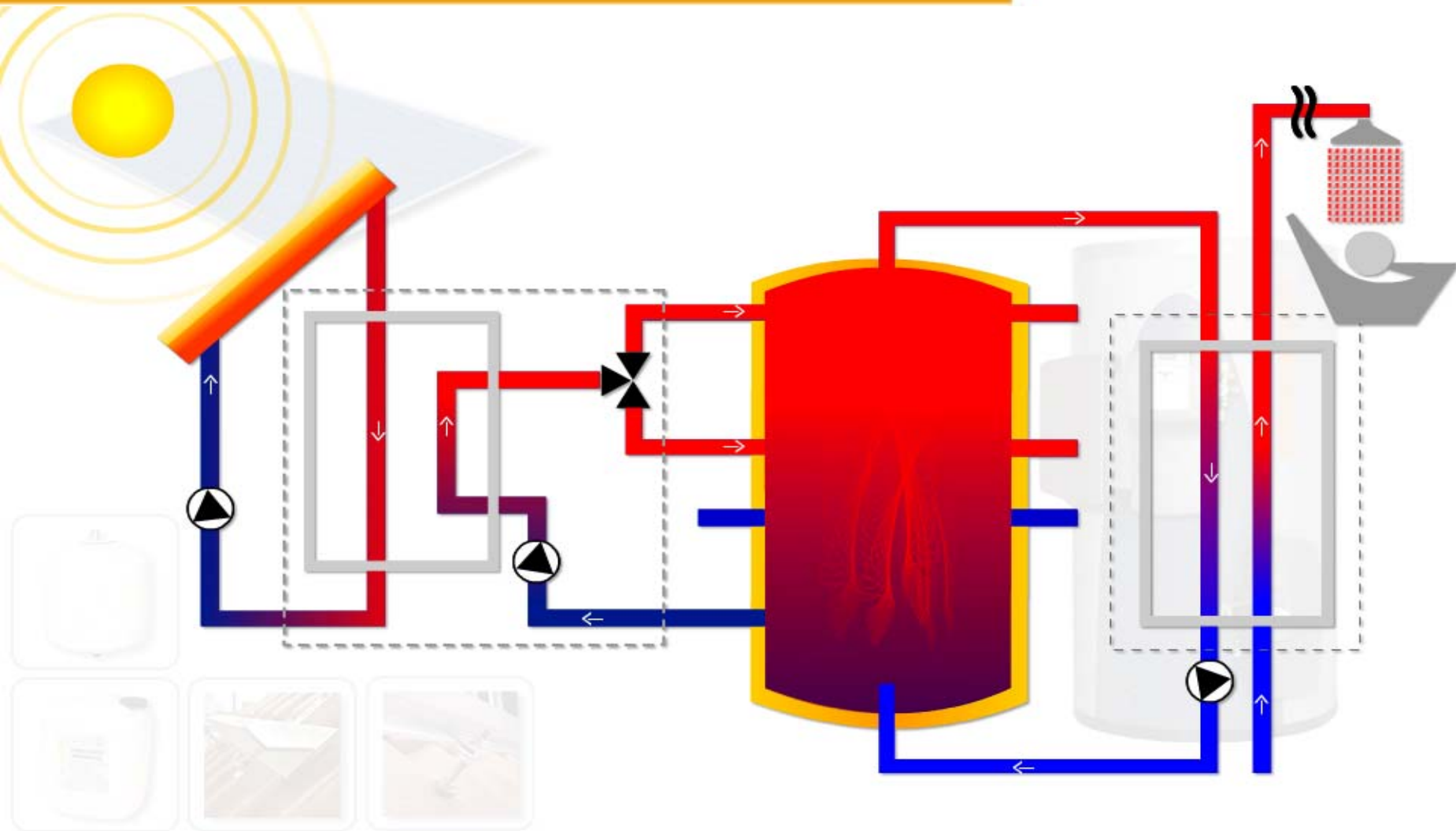









THE FUTURE OF ENERGY



# COMFORT plus - dimenzioniranje

**Sonnenkraft**

**Zelo enostavno s pomočjo naših cenikov:**

Solarheizungssets			800 L	1000 L	1600 L	2000 L
<b>Personen</b>	Pers.		3 - 6	4 - 8	4 - 8	4 - 10
Anzahl der Kollektoren (SK500/IDMK)	Stk.		5x 	6x 	8x 	10x 
Kollektorfläche	m <sup>2</sup>		12,5	15,1	20,1	25,5
<b>Sets MIT Befestigung/Blecheinfassung</b>			<b>9.300,-</b>	<b>10.200,-</b>	<b>13.000,-</b>	<b>14.500,-</b>
Aufdach SK500N 	Befestigung Ziegeldach DBP 	Art.Nr.	150 537	150 543	150 549	150 555
	Befestigung Universaldach SSP 	Art.Nr.	150 538	150 544	150 550	150 556
Indach IDMK* 	Blecheinfassung Ziegeldach BEFKZ 	Art.Nr.	150 539	150 545	150 551	150 557
<b>Sets OHNE Befestigung/Blecheinfassung</b>			<b>8.600,-</b>	<b>9.500,-</b>	<b>12.000,-</b>	<b>13.500,-</b>
Aufdach SK500N 	ohne Befestigung	Art.Nr.	150 540	150 546	150 552	150 558
Indach IDMK* 	ohne Blecheinfassung	Art.Nr.	150 542	150 548	150 554	150 560
Aufdach SK500L 	ohne Befestigung	Art.Nr.	150 541	150 547	150 553	150 559
<b>OPTION Wellrohrverbindungsset EWSID</b>			<b>740,-</b>	<b>740,-</b>	<b>740,-</b>	<b>740,-</b>
Wellrohrverbindung <b>EWS-SET20</b> , 15 lfm	IDMK	Art.Nr.	141 525	141 525	141 525	141 525
	SK500	Art.Nr.	141 526	141 526	141 526	141 526
<b>Set-Komponenten</b>						
COMFORT plus-Speicher (inkl. 4 PVS**)	Type		PSC800	PSC1000	PSC800 + PS800**	PSC1000 + PS1000**
Frischwassermodul FWM35 inkl. FWMPVS			✓	✓	✓	✓
Schichtlademodul SLM50 inkl. SLMPVS			✓	✓	✓	✓
Solarsteuerung SKSC3			✓	✓	✓	✓
Ausdehnungsgefäß	Type		AG33S	AG50S	AG80S	AG100S
Frostschutz	I		20	25	30	30



**Sistemske rešitve**

THE FUTURE OF ENERGY

# Sodobna rešitev: SLM50

**Sonnenkraft**

- Najvišja zmogljivost s komponentami visoke tehnologije
- Blokovna zasnova ⇒ kompaktna izvedba in minimalen potreben prostor
- Najpreprostejša montaža na steno in hranilnik PSC
- Optimalna možnost razširitve z modulom za ogrevalni krog HKM vkl. s SKSCHK1
- Polnjenje hranilnika v plasteh na 2 ravneh
- Regulacija SKSC3 v novi izvedbi, 3 izhodi z regulacijo števila vrtljajev, 1 brezpotencialni izhod
- Pripravljena za priključitev zahvaljujoč popolnemu električnemu predožičenju

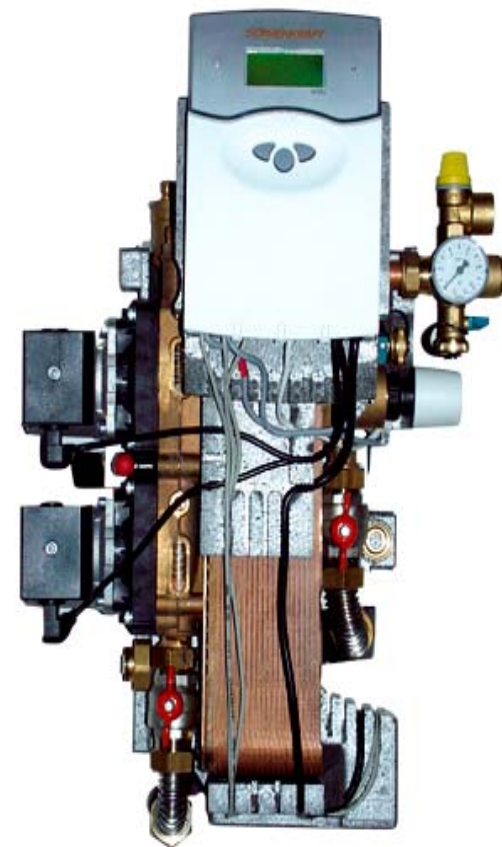

**Sistemske rešitve**

THE FUTURE OF ENERGY



## Inovacija!!

Navpične razplastne pločevine za razplastitev:

- povratka iz modula ogrevalnega kroga HKM
- predtoka (toplega) iz modula za polnjenje v plasteh SLM
- nastavkov (6/4") na nivojih B, C, D

Optimalno razplastitev zagotavljajo patentirane razplastne pločevine

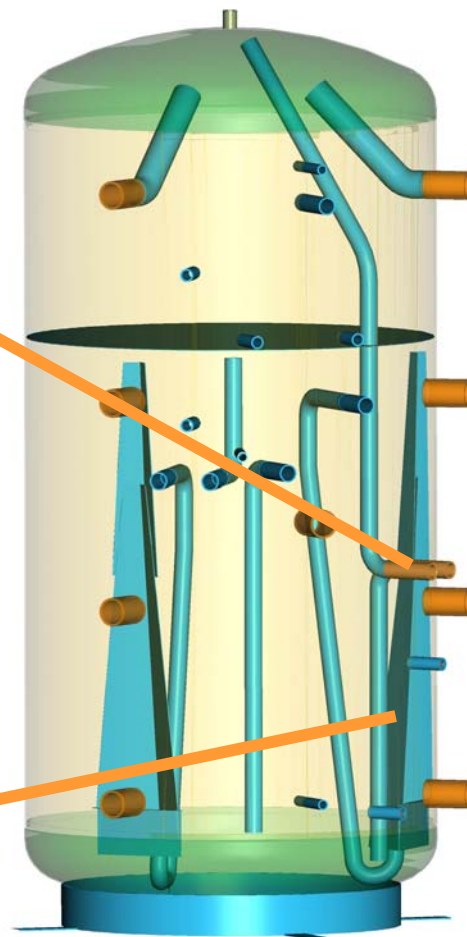
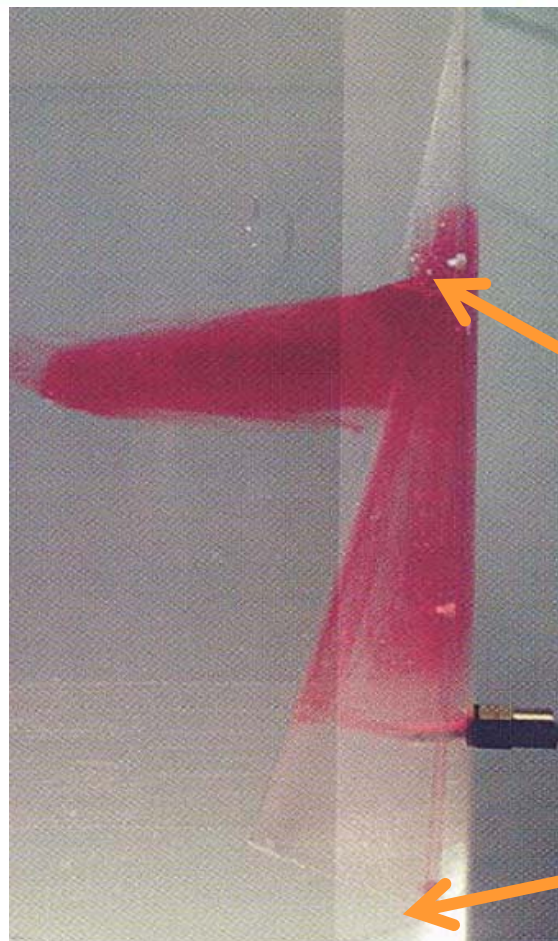

# COMFORT plus – shema sistema

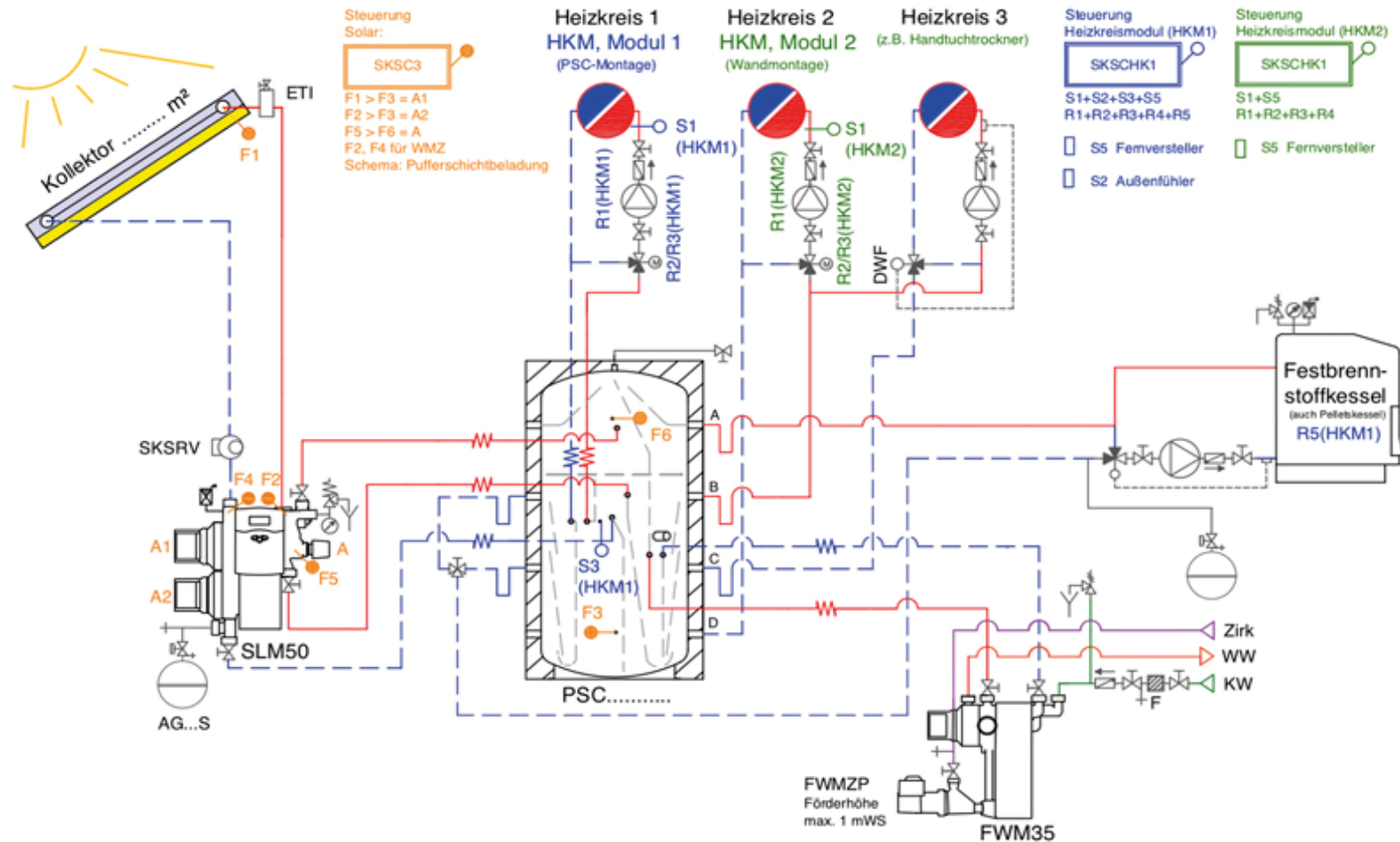

**Sistemske rešitve**



# COMFORT plus – shema sistema

**Sonnenkraft.**

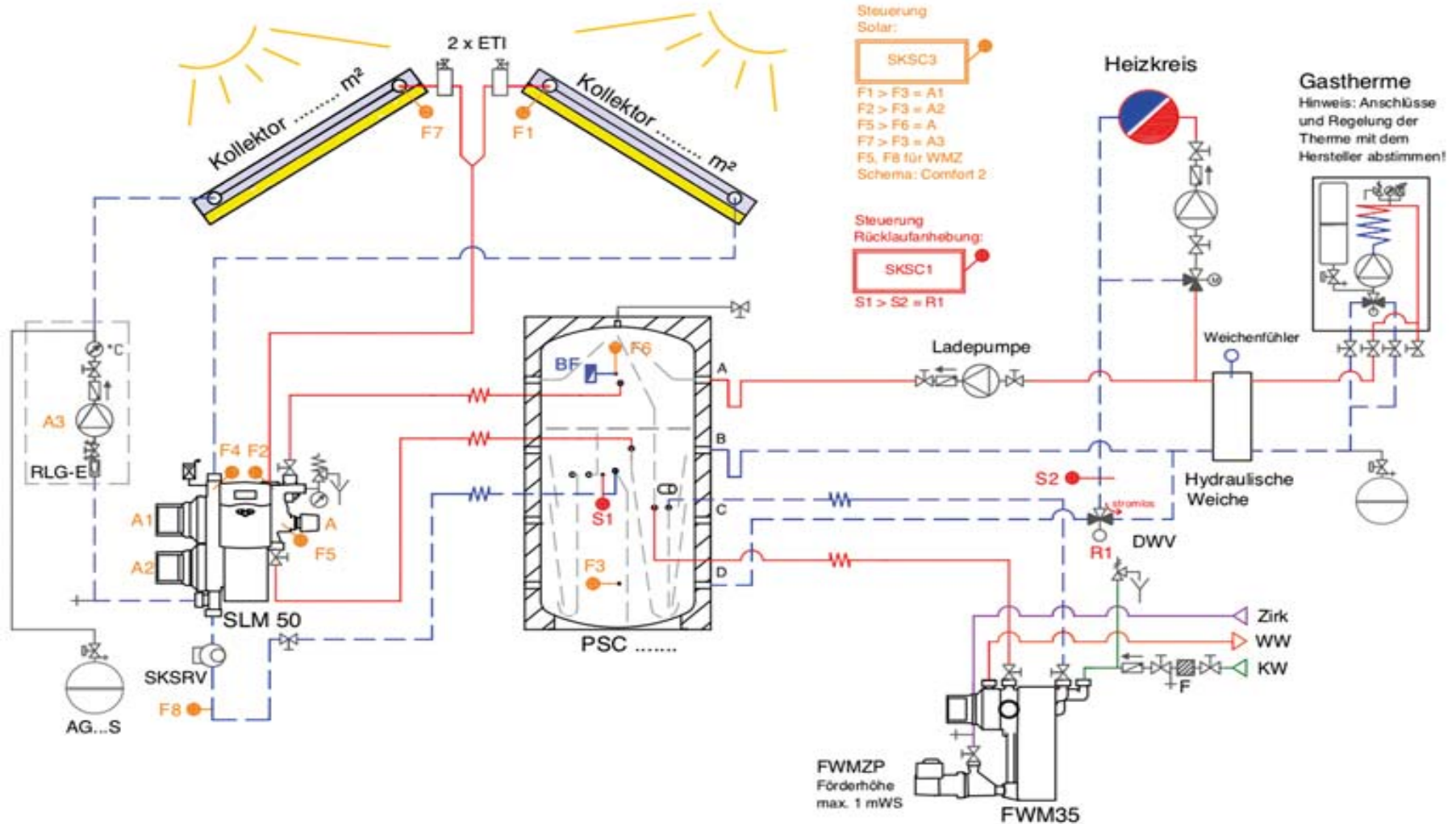

**Sistemske rešitve**

THE FUTURE OF ENERGY



# COMFORT plus – shema sistema

**SONNENKRAFT.**

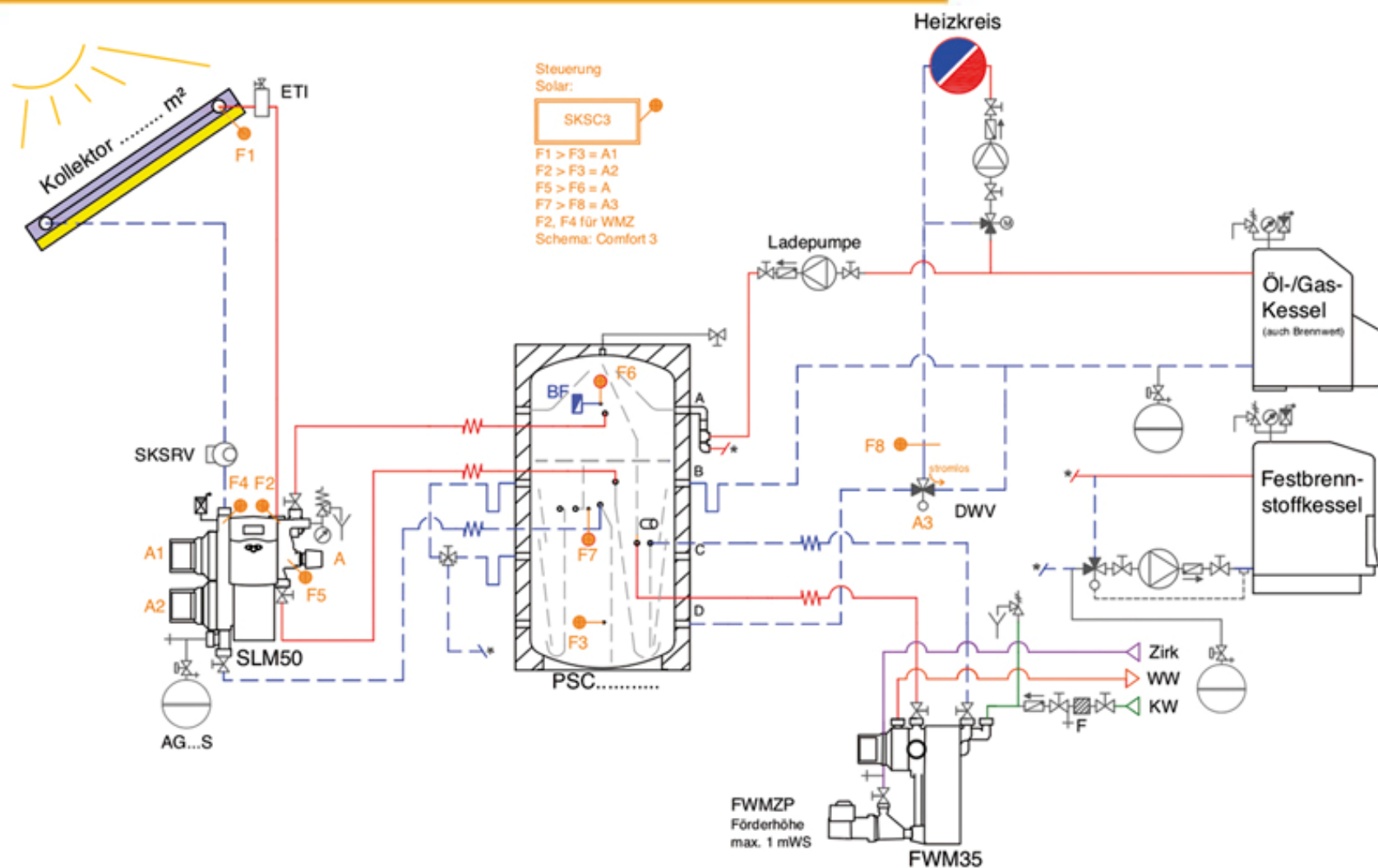

**Sistemske rešitve**

THE FUTURE OF ENERGY





**Sistemske rešitve**

THE FUTURE OF ENERGY

**Hvala za vašo pozornost!**

